



Assembly, Installation, Operation and Maintenance Instructions

Kit, Base Rail Bracket

Part # 31409

Dealer / Installer:	Provide a copy of these Instructions to the end user of this product. These Instructions provide important operating and safety information for proper usage of this product. Demonstrate the proper use of the product with the end user. Have the end user demonstrate that they understand the proper use of the product.
End User:	Read and follow all instructions included in this manual. Ask your Dealer / Installer for assistance if you do not understand the proper use of the product. Never remove any decals from the product.

NOTE: This bracket kit is to be used with the 31323 4 Bolt Bed Rail Kit or 30686 10 Bolt Bed Rail Kit.

Complete Parts List			
Item No.	Part No.	Description	Quantity
1	ERD10774	Spacer, Tube 2-1/2"	2
2	ERD10659	Bracket, Angle	2
3	ERD10020	Plate, Spacer	4
4	ERD10029	Bolt, Wheel 1/2 -13 x 1-1/2"	4
5	ERD12189	Lock Nut, Serrated 1/2 -13	4
6	ERD10677	Bolt, Hex 5/8 -11 X 5-1/2"	2
7	ERD10021	Bolt, Hex 5/8 -11 X 3.25"	2
8	ERD12188	Washer Flat (5/8)	6
9	ERD12187	Washer, Lock (5/8)	4
10	ERD12184	Clip Nut, (5/8 -11)	4
11	ERD10031	Spacer, Block 1"	4
12	ERD10030	Pull Wire 1/2"	1

For updates see the **PRODUCT SUPPORT** tab at www.huskytow.com

Center Bolt Kit 32059 must be used when towing with a 26K hitch, Goose Neck, or Maneuvering System (not included).

CAUTION: Do not install mounting rails over plastic bed liners. Plastic bed liners must be cut out of the way. Rails may be installed on spray in liners.

NOTE: Consult spray liner installer for recommended curing time.

Tools Required
3/4" Socket & Wrench
15/16" Socket & Wrench
5/8" Drill Bit
17/32" Drill Bit
Drill
Ratchet
Torque Wrench
Safety Glasses

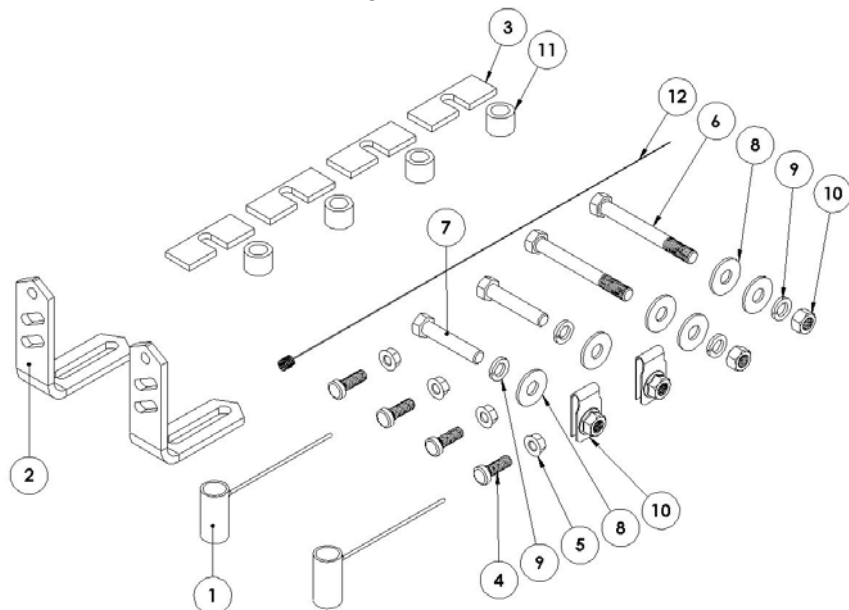

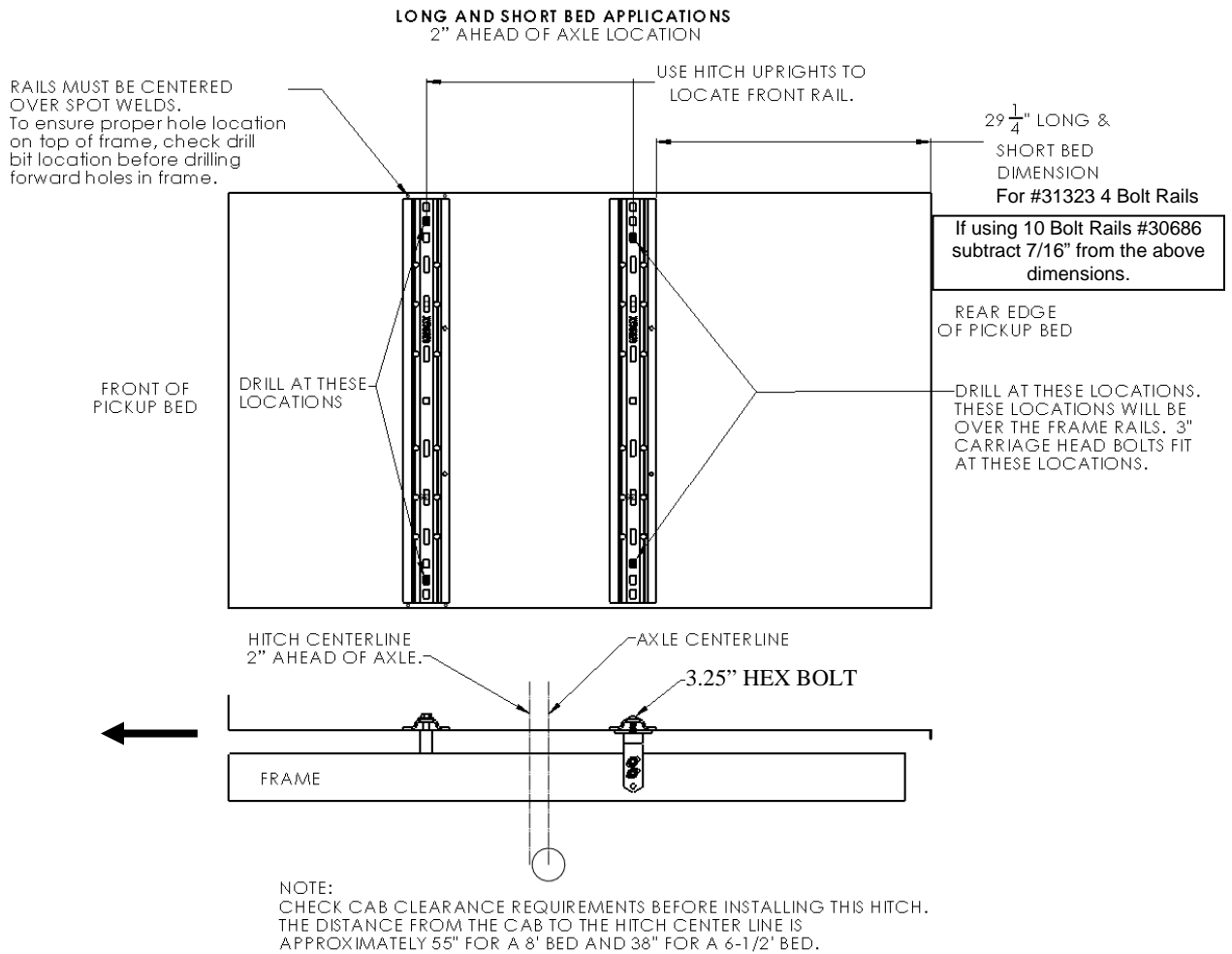

1. Place the two bed rails across the truck bed between the wheel wells. Position the 5th wheel uprights between the bed rails so that the tabs in the base of each upright will fit into the slots in the ends of the bed rails. Secure the uprights in place with the rail hitch pins and hair pins supplied with the 5th wheel installation kit. Securely attach 5th wheel cross member to uprights.
2. Position the bed rail assembly in truck bed as shown on the Illustration above. When hitch is correctly positioned in the bed and the bed rails are parallel, mark four attachment points on the truck bed using the 5/8" square holes indicated on the layout Illustration above. Check below the bed before drilling holes to see that all wiring, brake lines or other obstructions are moved out of the way and will not be contacted by the drill. Move the hitch assembly out of the way and drill four 5/8" diameter attachment holes down through the bed at the previously marked points.
3. Reposition the bed rails in the bed so that the square 5/8" hole in the end of each rail is lined up over the drilled holes. Place a 1" thick spacer block (#11) under ends of each bed rail, in line with drilled holes. See Illustration 1.
4. If the bed corrugation above the angle bracket is UP, leaving a space above the angle bracket, place a spacer plate (#3) in this location as shown on Illustration 2. If the corrugation is DOWN, at this location, place a spacer plate (#3) in the bed, under the base rail as shown on Illustration 2. Bolt parts loosely in place as illustrated.

Illustration 1

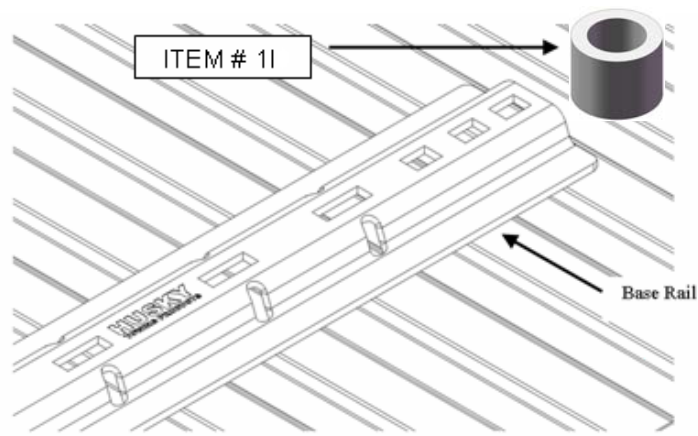
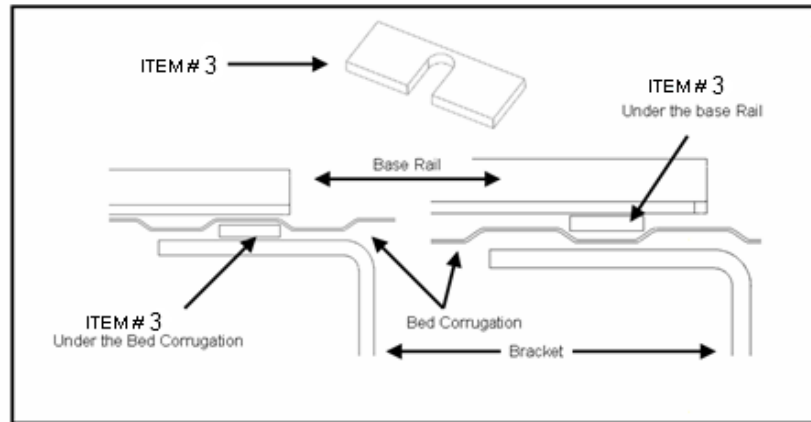
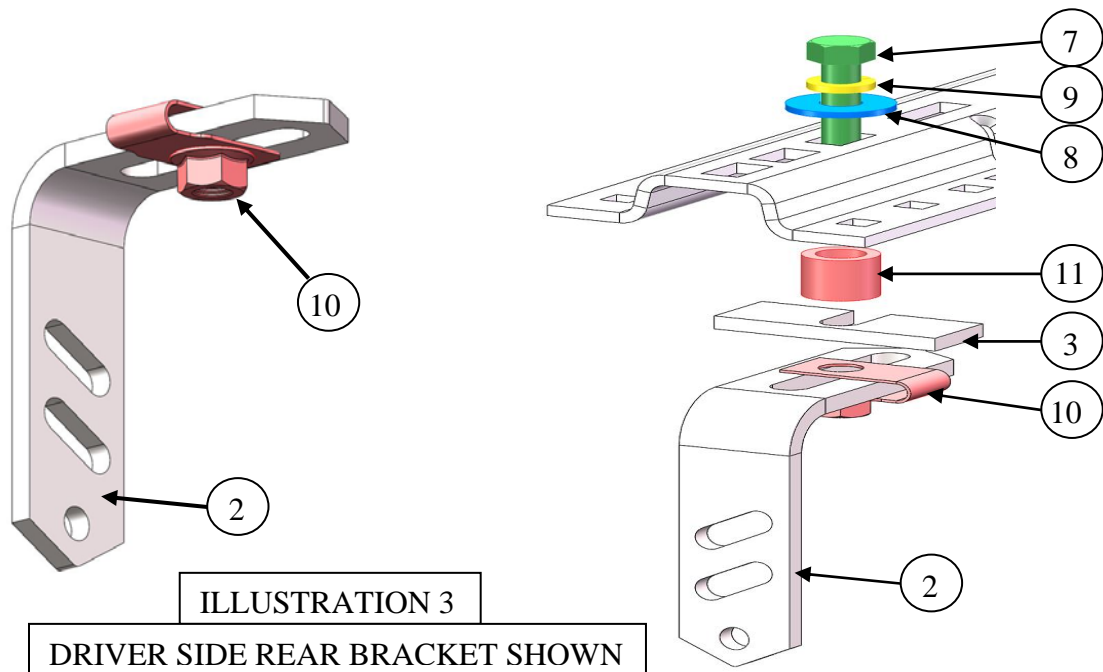

Illustration 2



- Position angle brackets under the bed, at the rear attachment and align with the 5/8" hex bolts protruding down through 5/8 lock washer (#9), 5/8 flat washer (#8). Secure bolt with clip nut (#9) the bed. Place the tube spacer between the bed and vehicle frame at forward attachment point. Drop the 5/8" hex bolt down through 5/8 flat washer (#8) rail spacer and frame at this location.



- Move the installed angle brackets so that they rest tightly against the flat side of the truck frame and underneath surface of truck bed. Securely bolt base rails in place. Be sure the angle brackets are tight against the side of truck frame. Tighten each 5/8" bed rail attachment bolt to 150 ft-lbs. torque. Failure to tighten bolts as described may result in fastener loss or failure. **DO NOT** apply torque to the nut portion of the clip nuts(#10). You will **DAMAGE** it.

- Before drilling any holes, check inside the frame to be sure that there are no wires, brake lines or other obstructions in the frame which may be contacted by the drill. Each of the angle brackets must be attached to the side frame of the truck with two special 1/2" wheel bolts. Drill two 17/32" holes through the side of the truck frame using two of the holes in each angle bracket as guides. See Illustration "A".

CAUTION: Holes MUST be drilled 17/32" diameter, so that the special wheel bolts will seat properly. If holes are too small, the bolt may break. If hole is too large it will not grip properly.

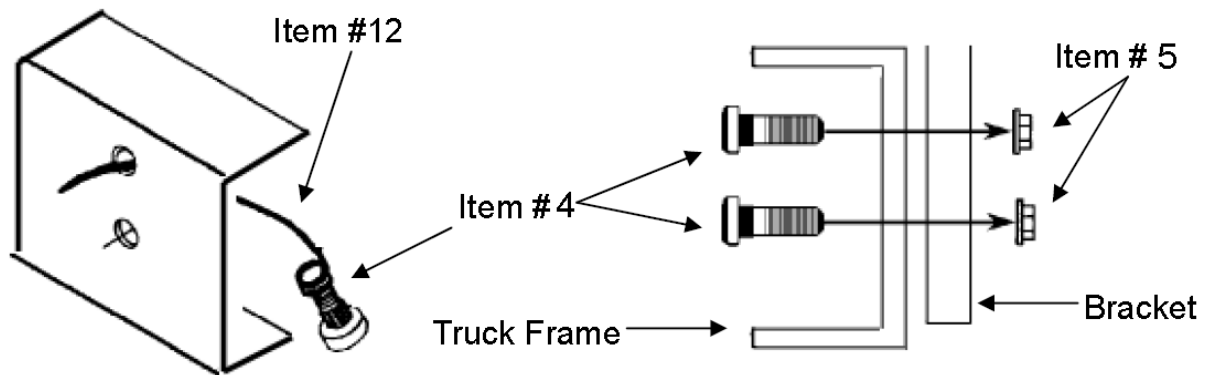
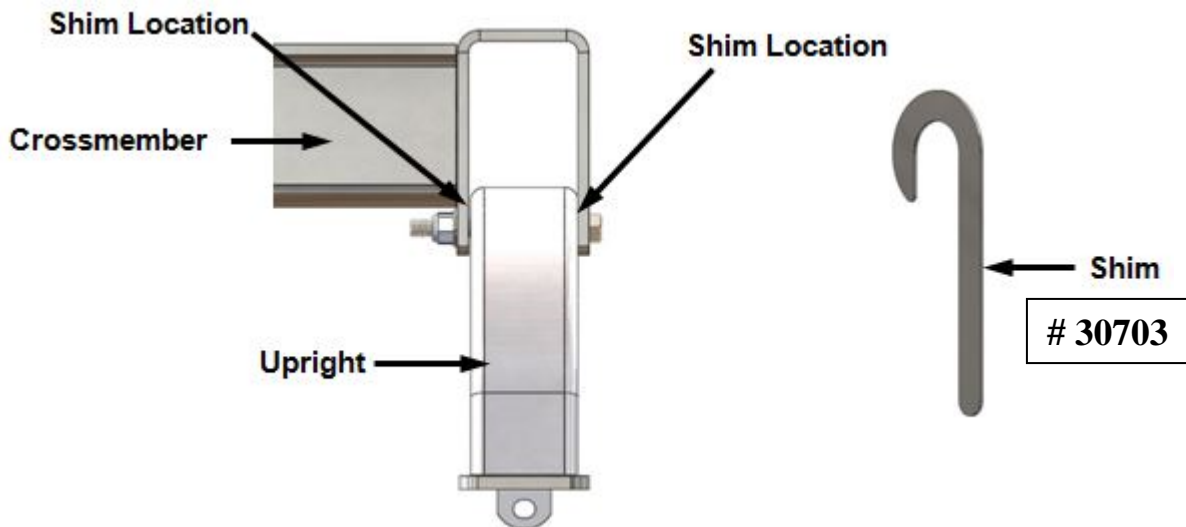

ILLUSTRATION "A"

- Place the two special bolts into the frame first and then out through the angle brackets. See Illustration "A". Some applications will require the use of a pull wire to align the bolts in to the drilled holes in the frame. Thread the pull wire coil over the end of the wheel bolt and pull through frame and angle bracket. See Pull Wire Illustration. Secure each bracket to the truck frame. The knurled portion of the bolts will lock into the frame holes as the nuts are tightened. Use of an air wrench will make installation much better.
- Tighten all 1/2" attachment bolts to 75 ft.-lbs. torque.
- Check each rail hitch pin for freedom of movement in the bed rail connection before tightening the 5/8" hex bolts. Adjust uprights, if necessary, by placing a washer between the upright and the cross member to obtain free pin movement. See Illustration "B".



- Tighten each 5/8" bed rail attachment bolt to 150 ft.-lbs. torque. Failure to tighten bolts as described may result in fastener loss or failure. DO NOT apply torque to the nut portion of the clip nuts. You will DAMAGE it.

Warranty Terms:

5 Year Limited Warranty:

This warranty applies solely to Husky 5th Wheel Installation Kits manufactured by LKQ Specialty Products Group for Husky Towing Products.

Husky Towing Products and LKQ Specialty Products Group make no guarantees or warranties for products not manufactured by LKQ Specialty Products Group. Such products are covered solely under any applicable warranty of the manufacturer. It is always recommended that the operating instructions and guarantee instructions provided by the manufacturer are followed.

LKQ Specialty Products Group warrants its products to be free from manufacturing and material defects to the original purchaser for the length of warranty stated above from the date of retail purchase. If any products are found to have a manufacturing or material defect, the product will be replaced or repaired at the option of Husky Towing Products and LKQ Specialty Products Group with proof of purchase by the original purchaser. The original purchaser shall pay all transportation and shipping costs associated with the return of the defective product and the defective product shall become the property of LKQ Specialty Products Group.

The Warranty applies to LKQ Specialty Products Group products used for individual and recreational purposes. Commercial usage of the LKQ Specialty Products Group products limits the warranty to 90-days from date of purchase.

The Warranty applies only to LKQ Specialty Products Group products which are found to be defective in manufacturing or material. This warranty does not apply to normal wear and tear of the finished product placed on LKQ Specialty Products Group products.

Husky Towing Products and LKQ Specialty Products Group are not responsible for any labor costs incurred for removal or replacement of the defective product. Husky Towing Products and LKQ Specialty Products Group are not responsible for repair or replacement of any product under the limited warranty where the product was improperly installed, misapplied, altered, abused, neglected, overloaded, misused or damaged as a result of an accident, including any use of the product not in accordance with all product operating and safety instructions.

Without limiting the generality of the foregoing, Husky Towing Products and LKQ Specialty Products Group shall under no circumstances be liable for any incidental or consequential loss or damage whatsoever arising out of, or in any way relating to any such breach of warranty or claimed defect in, or non-performance of the products. Some states do not allow the exclusion or limitation of incidental or consequential damages, so the above exclusion or limitation may not apply to you.

This limited warranty gives you specific legal rights, and you may also have other rights that vary from state to state.